

Combi-Line

Design your ceiling



HunterDouglas 
Architectural

Combi-Line

Be inspired by the endless possibilities of Combi-line and design the ceiling the way you always wanted.

Product : Combi-Line
Pattern : Pause

Endless Possibilities

Combi-Line is an exciting new carrier system for suspended ceilings that promises to create endless design opportunities for architects.

Combi-Line features a unique carrier rail system fitted with a variety of clips that fit a mix of metal, veneered wood linear and HeartFelt® panels, enabling the three different materials to be fitted on to a single carrier. Endless combinations are possible: ceilings with ruptured lines, random patterns and open positions in the grid, non-standard modulation and the opportunity to mix and match a range of ceiling panels in different materials.

Inspiration for endless design

Combi – Line was first created as a bespoke carrier system for a recently completed major project.

Hunter Douglas Architectural's Research and Development team worked with the project architects to produce a carrier with clips that allowed them to install ceiling panels in random patterns and with wide open spaces that revealed the plenum. The team realised this bespoke carrier system had potential, and decided to develop it further.

The result is the **new Combi-Line**.

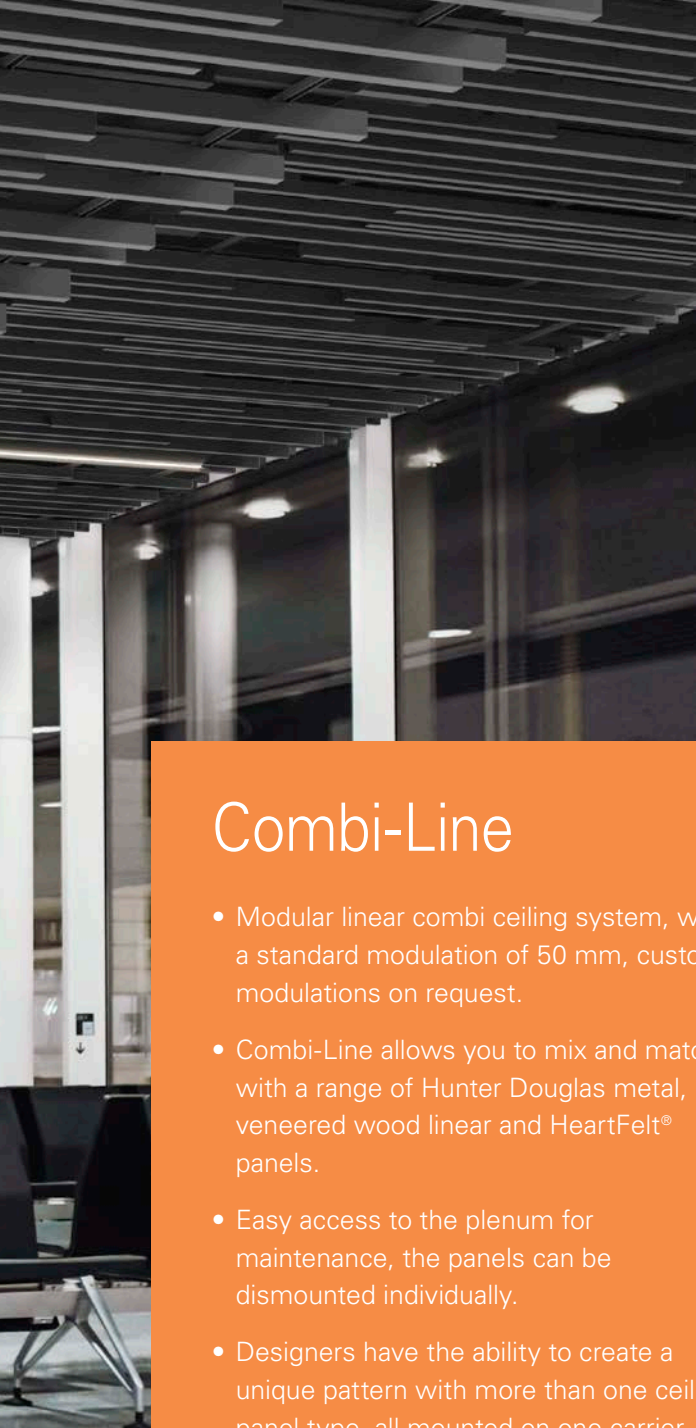

Combi-Line

- Modular linear combi ceiling system, with a standard modulation of 50 mm, custom modulations on request.
- Combi-Line allows you to mix and match with a range of Hunter Douglas metal, veneered wood linear and HeartFelt® panels.
- Easy access to the plenum for maintenance, the panels can be dismantled individually.
- Designers have the ability to create a unique pattern with more than one ceiling panel type, all mounted on one carrier.
- Combi-Line is available with HeartFelt® 30HL60, metal 30BD/BXD and veneered wood 30WL60 linear panels, with a system height of 118,9 mm and panels lengths up to 6,000 mm.



Product : Combi-Line
Pattern : Repeat

CONTENTS	Page
Combi-Line	2
Patterns	4
Colours	5
Combi-Line Ceiling	6
Hunter Douglas Architectural	7

HunterDouglas 
Architectural



Designed to work for you

Patterns

Three themes for spectacular designs,
Play, Repeat and Pause

Play

Combination of materials in 1 module.



Repeat

Combination of materials in variable modules and
variable densities.

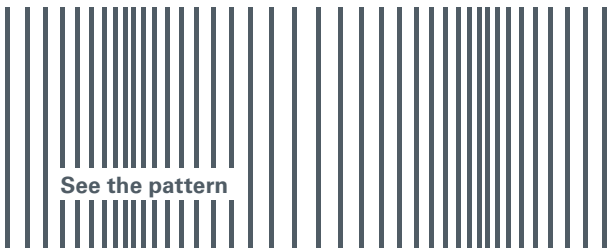

Pause

Random patterns with one or more materials featuring
ruptured lines.



Colour Combinations

The unique modular nature of the Combi-Line system allows the designer to design a creation from four colour combinations and four completely different ceiling styles, each with its own unique colour and finish.

There is a wide selection of materials and products available to enable the architect to be truly creative with the room space he or she is creating. Each style group consists of a selection of materials that helps create a mood board and a matching space where the product can be applied.

Four Style Groups

Combi-Line system is available in four colour styles and a variety of materials.

Modest Elegance : A style that matches interiors characterized by understated luxury.

Material choice : Dark matt metal, luxurious wood types such as walnut and oak and deep dark HeartFelt® shades.

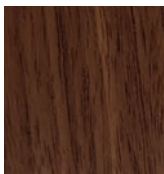

Veneer walnut

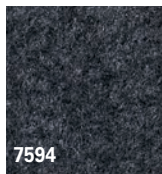

7594

HeartFelt® black



1883

Metal matt black

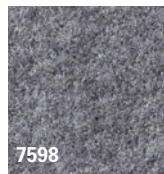

7598

HeartFelt® dark grey



1585

Metal matt grey

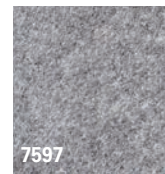

7597

HeartFelt® middle grey



Veneer European Oak

Natural Purity : A style that matches a pure and natural interior.

Material choice : Warm umber tones HeartFelt®, warm deep wood tones such as walnut and cherry, with even the metal range available in similar tones.

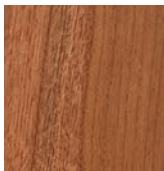

Veneer cherry



Veneer walnut



7579

HeartFelt® umber



7577

HeartFelt® medium brown



4648

Metal warm beige



7575

HeartFelt® creme



0581

Metal grey-white

Linear Minimalist : A style that matches the sleek minimalist interior.

Material choice : Greyed shades of HeartFelt® combined with silver, black and white metal.



1883

Metal matt black

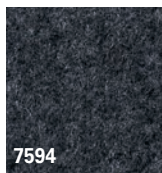

7594

HeartFelt® black



7596

HeartFelt® light grey

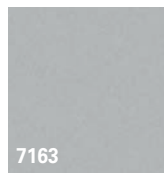

7163

Metal metallic



7593

HeartFelt® white

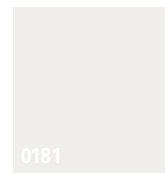

0181

Metal matt white

Soft Scandinavian : A style that is characterized by light colours and a soft yet business-like minimal appearance.

Material choice : Light metallic colours interspersed with soft greyish HeartFelt® shades and light wood.



Veneer maple



Veneer oak



Veneer bamboo

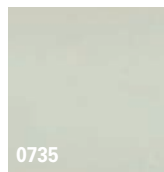

0735

Metal moss green

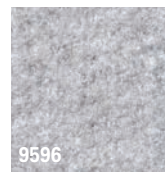

9596

HeartFelt® light grey



7593

HeartFelt® white

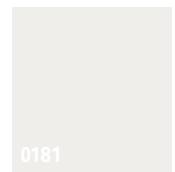

0181

Metal matt Scandinavian white

Installation

The Combi-Line panels are attached to our carrier rail system. Each panel is attached with a steel clip that clicks into the carrier rail. Only the Veneered Wood panels are then locked into place using a sliding clip on each connection with the carrier rail. There is easy access to the plenum for maintenance, as the panels can be dismantled individually.

System Overview

- 1 = Wood panel 30WL60
- 2 = Metal Linear 30BD/30BXD
- 3 = HeartFelt® 30HL60
- 4 = Combi-Line clip wood 30
- 5 = Combi-Line clip 30BD/30BXD
- 6 = Combi-Line clip HeartFelt® 30
- 7 = Universal Carrier
- 8 = Combi-Line stabilisation bracket
- 9 = Combi-Line stabilisation profile
- 10 = Quick hanger
- 11 = Nonius hanger

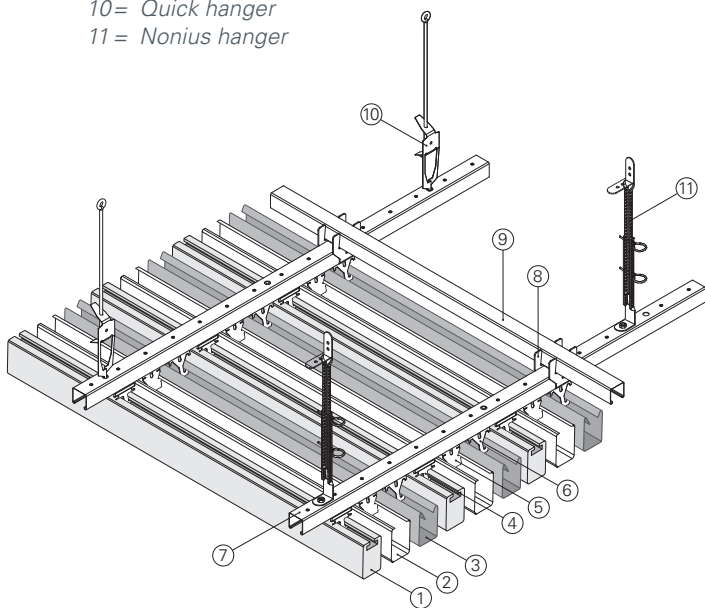

Profile

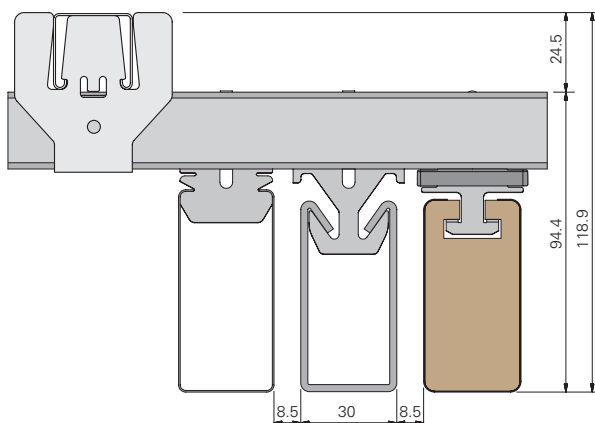

Acoustics

The acoustic performance in an office space, school or public building contributes to our well-being. Poor acoustics can affect health, communication, safety, productivity and learning. Hunter Douglas Architectural's high performance acoustic ceiling products are the best solution to deliver outstanding acoustic performance, comfort and an aesthetically pleasing environment. With the Combi-Line ceiling system an absorption value (α_w) up to 0.70 can be obtained, depending on the ceiling and panel configuration.

SUSTAINABLE PROPERTIES

Veneered Wood

FSC

Hunter Douglas is committed to protecting our forests for future generations. NC-COC-016324.



Metal

C2C CERTIFICATION

- C2C Bronze certificate
- The product meets the 'Low' requirements for use in low-polluting buildings.



BUILDING CERTIFICATION

- VOC emissions class A+
- Suitable for BREEAM and Leed



HeartFelt®

C2C CERTIFICATION

- C2C Bronze certificate
- The product meets the 'Low' requirements for use in low-polluting buildings.



BUILDING CERTIFICATION

- VOC emissions class A+
- Suitable for BREEAM and Leed



VOC EMISSIONS

- BREEAM-Nor: approved
- M1: approved
- French regulations for CMR substances: approved

In the last 60 years, we have been fortunate enough to help turn countless innovative ideas into products for innovative buildings. With major operation centres in Europe, North America, Latin America, Asia and Australia we contribute to thousands of high-profile projects including shopping centres, airports, government offices, hospitals, universities and offices.



▲ CEILINGS



▲ WALLS



▲ SUN LOUVRES



▲ FAÇADES

Architectural services

We support our business partners with a wide range of technical consulting and support services for architects, developers, and installers. We assist architects and developers with recommendations regarding materials, shapes and dimensions, colours and finishes.

We also help creating design proposals, visualisations, and installation drawings. Our services to installers range from providing detailed installation drawings and instructions to training installers and advising on the building site.



Hunter Douglas adopts the cradle to cradle (C2C) product philosophy to the design of products that fit the circular paradigm. They are designed for longevity, using materially healthy technical nutrients that can be reused at end of life as a high-quality source for something new.

Cradle to Cradle Certified™ is a certification mark licensed by the Cradle to Cradle Products Innovation Institute.



Hunter Douglas products and solutions are designed to improve indoor environmental quality and conserve energy, supporting built environments that are comfortable, healthy, productive, and sustainable.



All steel products are 100% recyclable at the end of their lifecycle.



Printed on EU Ecolabel certified paper



All aluminium products are 100% recyclable at the end of their lifecycle.

More information

Contact our **Project Support** for further help and advice on the design possibilities our applications can create.

Call us:
+31 (0)10 - 486 99 11

Send us an e-mail:
info@hunterdouglasarchitectural.eu

Visit our website:
www.hunterdouglasarchitectural.eu

ASIA | AUSTRALIA | LATIN AMERICA | NORTH AMERICA

Austria
Belgium
Bulgaria
Croatia / Slovenia
Czech Republic
Denmark
France

Germany
Greece
Hungary
Israel
Italy
The Netherlands
Norway

Poland
Portugal
Romania
Russia
Serbia
Slovakia
Spain

Sweden
Switzerland
Turkey
United Kingdom
South Africa
Middle East

CEILINGS



WALLS



SUN LOUVRES



FAÇADES



HUNTER DOUGLAS ARCHITECTURAL EUROPE

Piekstraat 2
P.O. Box 5072 - 3008 AB Rotterdam
The Netherlands
T. +31 (0)10 - 486 99 11
info@hunterdouglasarchitectural.eu
www.hunterdouglasarchitectural.eu